

LEYLAND-TRIUMPH SALES COMPANY, INC.

WESTERN ZONE

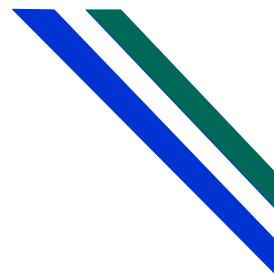

TO: ALL TRIUMPH DEALERS - WESTERN ZONE

ATTN: SERVICE & PARTS

BULLETIN T-64-3

SUBJECT: LAYCOCK OVERDRIVE

DATE: JANUARY 3, 1964

Two basic types of unit known as "A" and "D" are produced. The former is used on cars of two litres (120 Cu. in.) upwards; the "D" type on smaller models.

Both units are pressurized by a plunger type pump, cam operated from the input shaft. Oil is drawn through a filter and delivered to the operating valve. Type "A" incorporates a hydraulic accumulator in the system, type "D" a relief valve. Pressures vary according to the installation but on larger units it is usually 360-520 lb. sq. in. (25.3-36.5 kgs. sq. cm.) and in the smaller about 480 lbs. sq. in. (33.75 kgs. sq. cm.).

Being interconnected, the gearbox and overdrive use a common oil supply, the level of which is indicated by the level plug or dipstick of the gearbox. Although the overdrive unit is filled through the gearbox, separate drain plugs are provided and both must be removed when draining. The overdrive has a gauze filter which should be cleaned whenever the oil is changed. Great care must be taken to avoid entry of dirt whenever any part of the casing is opened.

DIAGNOSIS OF FAULTS

If the overdrive does not operate properly check the oil level in the gearbox! overdrive unit. If low, top up with fresh oil and retest the operation before making a detailed investigation. Before dismantling any part of the overdrive, release all hydraulic pressure from the system by operating the valve setting lever by hand several times. To avoid unnecessary dismantling check for cause in the order listed under the heading below.

(Note: To obtain a hydraulic pressure reading on "D" type, overdrive must be engaged.)

LEYLAND-TRIUMPH SALES COMPANY, INC.

WESTERN ZONE

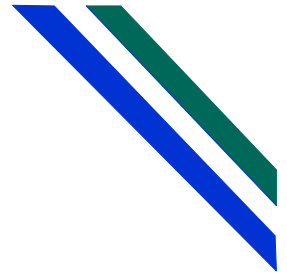

TO: ALL TRIUMPH DEALERS - WESTERN ZONE

ATTN: SERVICE & PARTS

BULLETIN T-64-3

SUBJECT: LAYCOCK OVERDRIVE

DATE: JANUARY 3, 1964

OVERDRIVE DOES NOT ENGAGE

- 1.. Insufficient oil in unit.
2. Solenoid not operating due to fault in electrical system.
3. Solenoid operating lever out of adjustment.
4. Insufficient hydraulic pressure due to pump non-return valve incorrectly seating (probably dirt on seat).
5. Damaged parts within the unit.

OVERDRIVE DOES NOT RELEASE

(Note: Do not attempt to reverse car or damage may be caused within the overdrive.)

1. Fault in electrical control system.
2. Blocked restrictor jet in operating valve.
3. Solenoid operating lever adjustment.
4. Sticking clutch.

CLUTCH SLIP IN OVERDRIVE

As 1, 3 and 4 "Overdrive does not engage."

5. Worn or glazed clutch lining.

LEYLAND-TRIUMPH SALES COMPANY, INC.

WESTERN ZONE

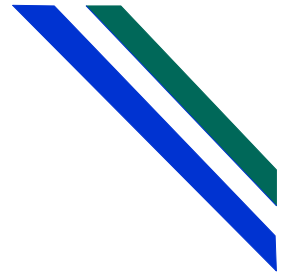

TO: ALL TRIUMPH DEALERS - WESTERN ZONE

ATTN: SERVICE & PARTS

BULLETIN T-64-3

SUBJECT: LAYCOCK OVERDRIVE

DATE: JANUARY 3, 1964

CLUTCH SLIP IN REVERSE AND FREE WHEEL ON OVER-RUN

1. Solenoid operating lever out of adjustment.
2. Partially blocked restrictor jet in operating valve.
3. Worn or glazed clutch lining.

ADJUSTMENT OF SOLENOID OPERATING LEVER

The solenoid operates a lever which is fastened to a shaft carrying the operating cam. In "A" type units, the lever is clamped to the shaft to facilitate adjustment with a setting arm on the opposite side of the unit.

With the solenoid energized the 3/16" (4.5 mm.) hole in the setting arm should align with a similar hole in the casting. The alignment of the holes should be checked by inserting the shank of a 3/16" (4.5 mm.) drill through the hole in the setting arm.

For adjusting the solenoid on "D" type see Service Bulletin 1-63-60. PUMP NON-RETURN VALVE (Figure 1)

In "A" type units access to the valve necessitates removal of the solenoid and solenoid bracket. The bracket is secured by two 5/16" (7.937 mm.) diameter studs and two t/16" (7.937 mm.) diameter bolts, the head of the bolts being painted RED. THE NUTS MUST BE REMOVED FROM THE STUDS BEFORE TOUCHING THE BOLTS. The two bolts should not be slackened off together releasing the compression on the accumulator spring which abuts the solenoid bracket.

After removing the valve plug, spring, plunger and ball, clean the seat and reset the ball by giving it a sharp tap with a suitable hammer and drift.

LEYLAND-TRIUMPH SALES COMPANY, INC.

WESTERN ZONE

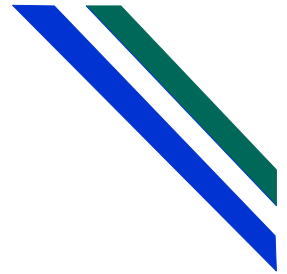

TO: ALL TRIUMPH DEALERS - WESTERN ZONE

ATTN: SERVICE & PARTS

BULLETIN T-64-3

SUBJECT: LAYCOCK OVERDRIVE

DATE: JANUARY 3, 1964

The "D" type has a detachable pump valve accessible from beneath the unit when the center plug is removed. The valve body can then be withdrawn by inserting a piece of stiff wire, bent into a hook, in the hole in the side of the body. After removal of the body, the valve plunger can be pushed out. Inspect the body, plunger, spring and "O" ring for damage. The plunger should be a sliding fit in the body.

OPERATING VALVE

The operating valve plug is located on top of the unit. Release hydraulic pressure, unscrew plug and remove spring, plunger and ball. A small magnet will be found useful for this operation. Remove operating valve by inserting a stiff piece of wire and drawing it up. Near the bottom of the valve will be seen a small hole breaking through the center drilling. Ensure that this is not choked (Figure 2).

If necessary, the ball can be reseated on top of the operating valve by placing the ball on a block of wood and sharply tapping the valve after positioning it on the ball. Clean the valve seat in the casing and if necessary reseat the ball by tapping it gently on its seat with a copper drift. Do not tap the ball too hard or the mouth of the hole will be closed up so that the valve cannot be reassembled.

An Instruction Manual covering the "A" type of unit is available from the Spares Division under publication number 502274. A Manual for the "D" type is in course of preparation.

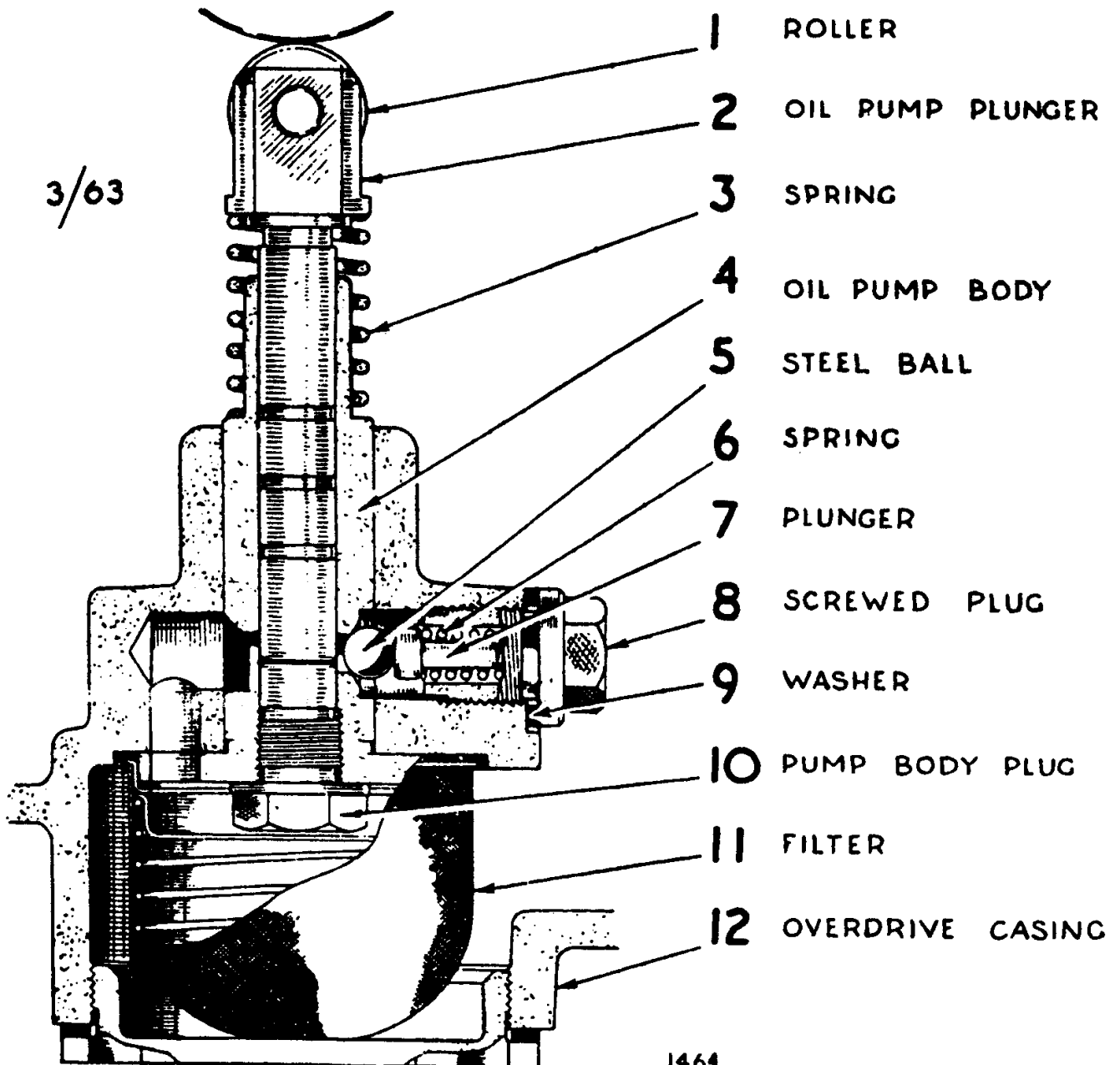
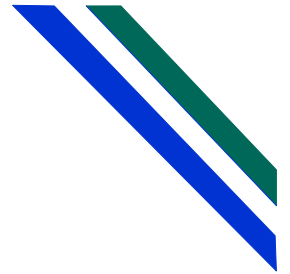

PUMP VALVE
A TYPE ONLY

FIG. 1

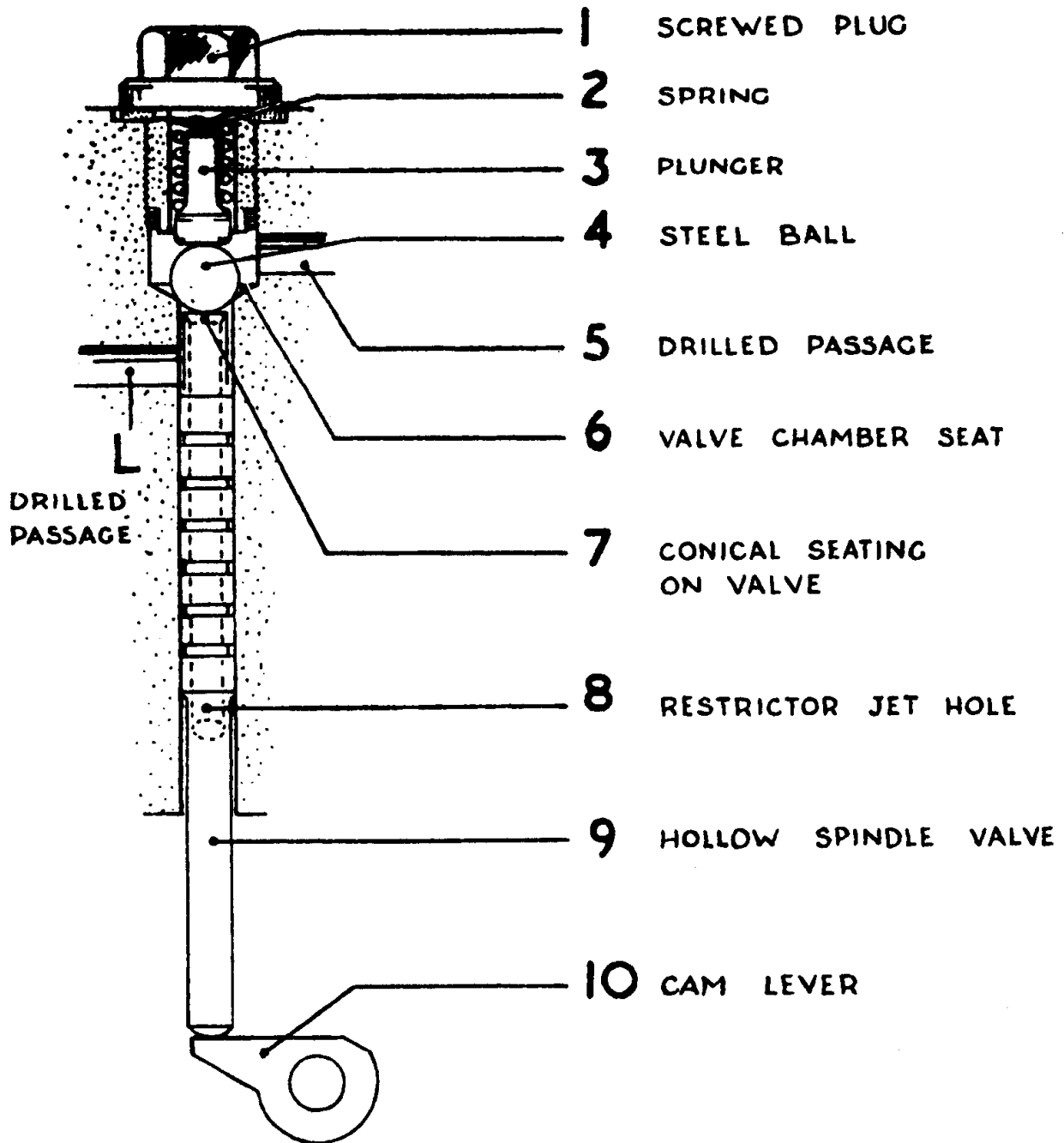
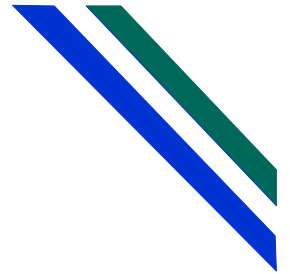

OPERATING VALVE
A AND D TYPE

3/63

FIG. 2